



Upgrade to Best-in-Class Stereolithography

Learn why customers are upgrading to the Stratasys Neo series of 3D printers for outstanding part accuracy, detail and sidewall quality.



Introduction

Users of legacy stereolithography (SL) 3D printers are often challenged with producing high-quality, accurate 3D printed parts for prototyping or tooling applications. Parts produced on legacy stereolithography 3D printers can at times be inaccurate, requiring lengthy finishing, which increases time and costs.

In this e-Book, find out why companies are upgrading to the Stratasys Neo® 3D printer series to produce 3D printed parts with outstanding sidewall quality, detail, accuracy and extremely small variability from part to part. Learn how the Neo compares to legacy stereolithography 3D printers and see how the Neo excels.



Sidewall

The Stratasys Neo has an optimized machine design and utilizes the latest cutting-edge technology available for laser and scanners. The Neo's beam delivery system produces exceptional layer-to-layer alignment repeatability, printing parts that are dimensionally accurate, with exceptional sidewalls and crisp feature resolution.

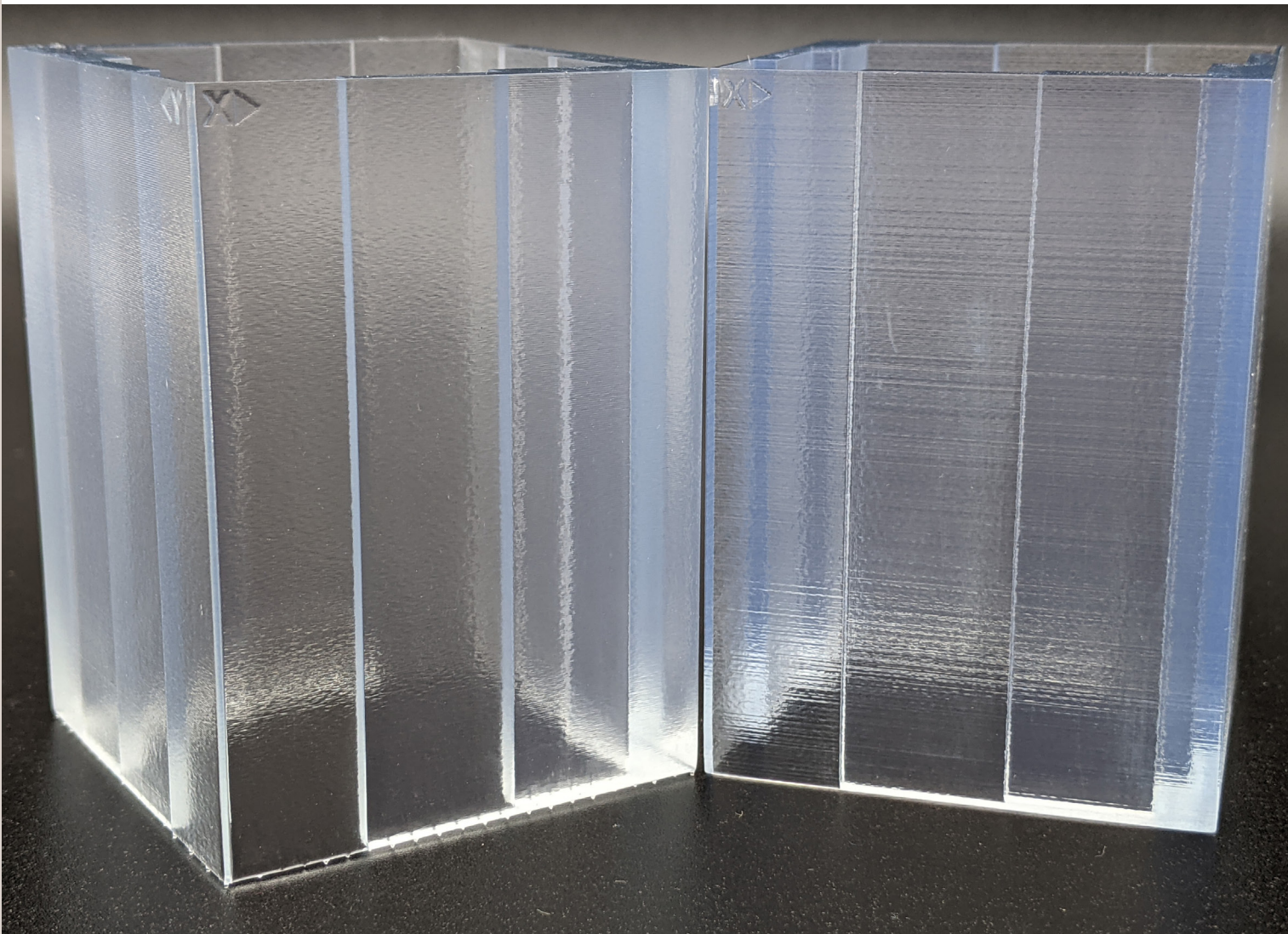

The image to the left show two different parts, one from the Stratasys Neo (left) and one from a legacy stereolithography 3D printer (right). The Neo's beam delivery system produces exceptional layer-to-layer alignment repeatability, resulting in printed parts that are accurate and detailed, with smooth sidewalls.

Parts printed on the Stratasys Neo have:

- Fewer visible stepping lines, resulting in reduced or no finishing
- Outstanding dimensional accuracy, with the ability to print very small detailed parts (dimensions $<100\text{ mm} \pm 0.1\text{ mm}$ and $>100\text{ mm} \pm 0.15\%$)

Surface Finish

The Stratasys Neo produces parts with exceptional sidewall surface finish.

The Stratasys Neo produces parts with exceptional sidewall surface finish. Surface roughness is measured by passing a sensor along the surface of a part, using an RA micrometer. The surface is measured when the sensor moves as it passes up and down the part. The less the sensor moves, the smoother the part is.

One 3D printed part from the Stratasys Neo and another part from a legacy 3D printer were measured for surface roughness. The legacy 3D printer part sidewall showed considerable variances in measurement, due to the layer lines on the surface of the part. In comparison, the Neo part had less than half the roughness of the legacy stereolithography part. Across all 4 sides, the Neo stayed under the +/- 10 μm range, while the legacy 3D printed part had a variance of up to +/- 50 μm range. Smoother part sidewalls reduce the time and cost of finishing or sanding parts.

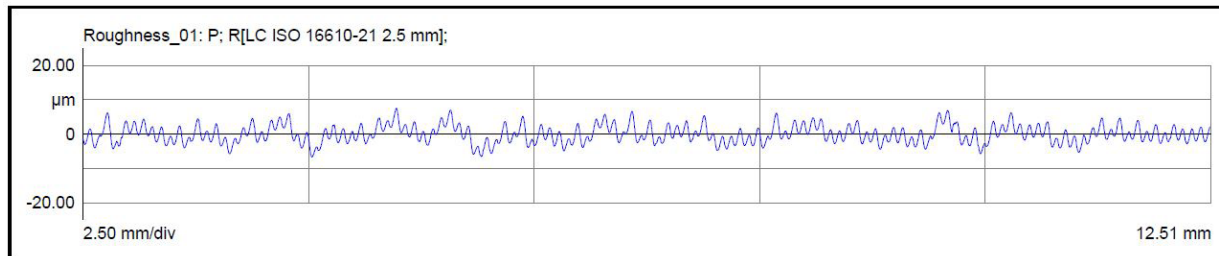

Data from surface roughness testing on one side of a Neo part

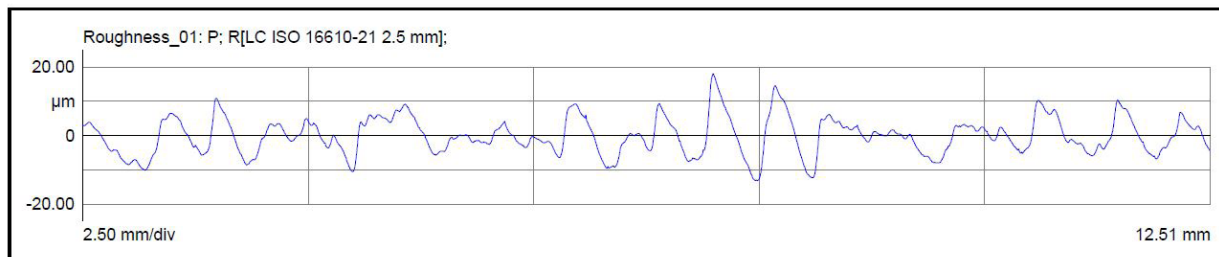

Data from surface roughness testing on one side of a legacy stereolithography part

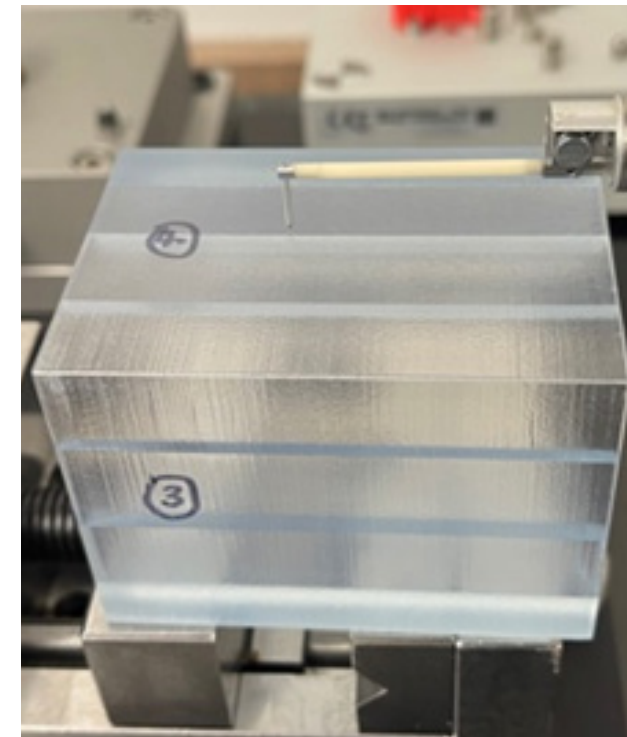

Measuring the RA values of a legacy stereolithography 3D printed part

* Test from third party source, captured August 2020

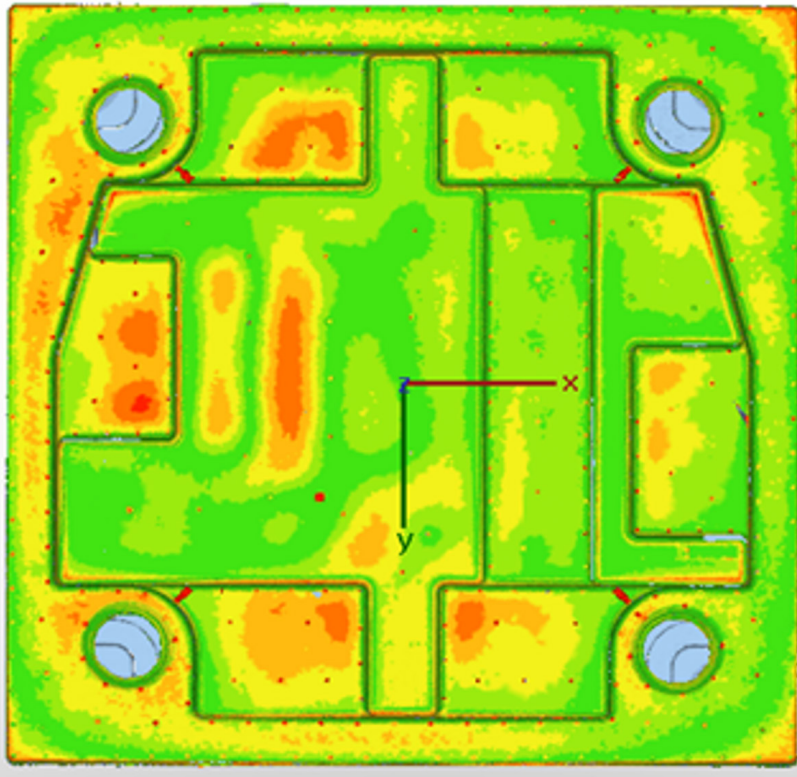

Scan of Neo800 part

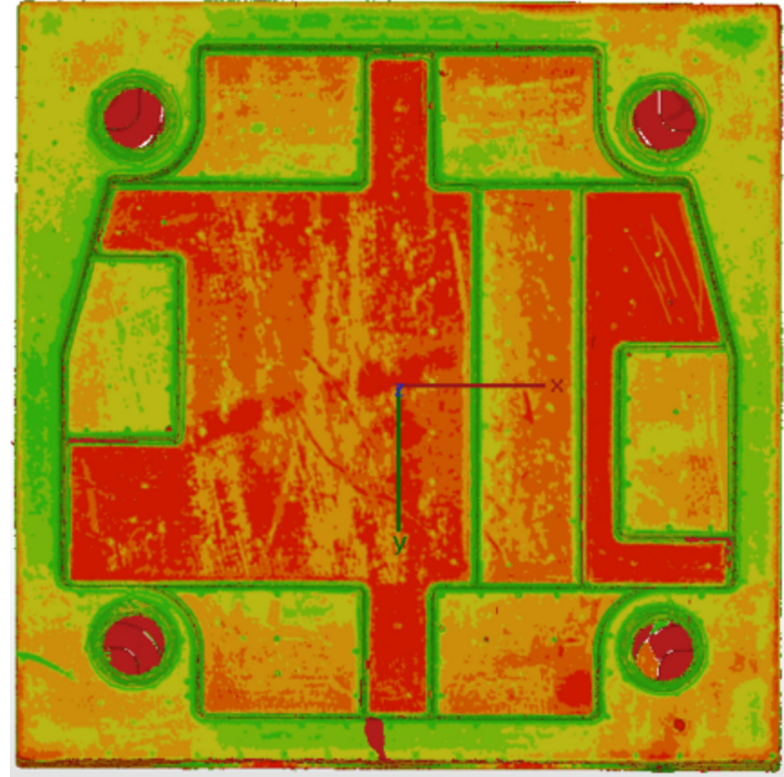

Scan of legacy stereolithography part

Accuracy

Can you tell which part was produced by the Stratasys Neo Stereolithography 3D printer?

Two identical parts were printed: one on the Stratasys Neo and the other on a legacy stereolithography 3D printer. Each part was scanned to determine the accuracy of its measurements.

As shown in the heat maps above, the Stratasys Neo part had low variances, while the legacy stereolithography 3D printed part had larger variances. On average, the Neo part had small variances of $\sim 40\text{-}80\ \mu\text{m}$, while the legacy part had considerable variances of $\sim 160\text{-}200\ \mu\text{m}$.

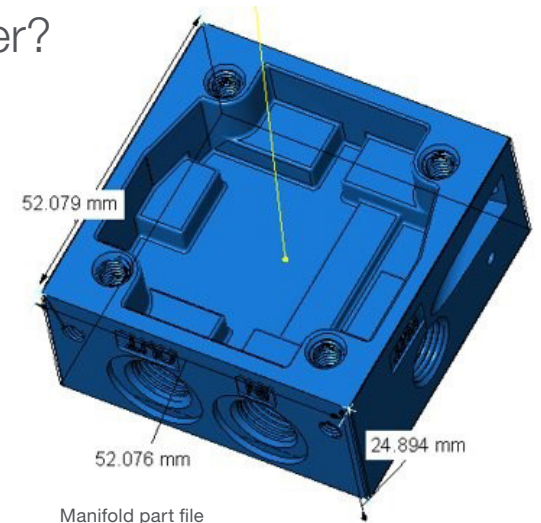

Manifold part file

*Build settings, parameters or resin use may differ for each part produced. Test from third party source, captured August 2020

Variability

The reliable and proven Stratasys Neo 3D printers build accurate parts across their entire platform. Parts are dimensionally accurate from corner to corner, offering peace of mind.

5 parts were built in the corners and at the center of a Stratasys Neo 3D printer platform, and the X and Y dimensions of each part measured within the 0.1 mm < 100mm dimension requirement. Each part was accurate, with the biggest variance being only 60 μm.

Less variability from part to part means more reliable part production, which is ideal for high-demand, fast-paced industries.

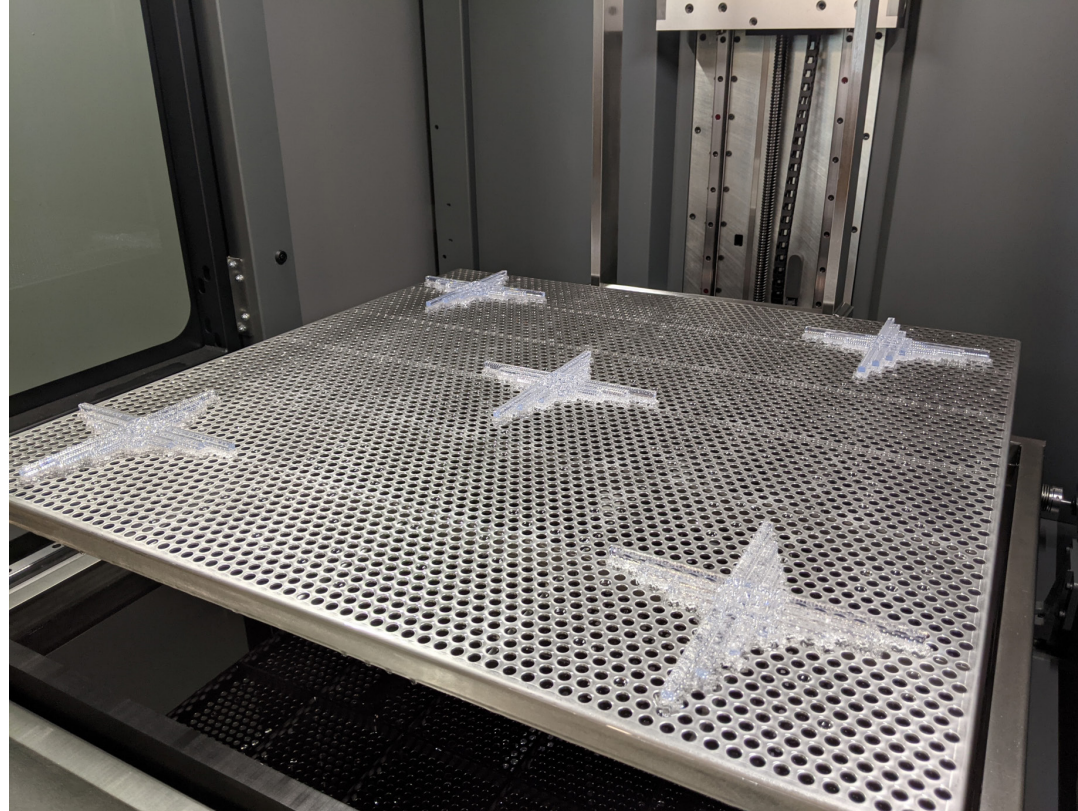

XY

800 Accuracy_Assessment

Build Settings
 Build Mode: **Standard Definition (SD)**
 X Scaling: **1.0014**
 Y Scaling: **1.0016**
 Z Scaling: **1.0000**
 Beam Comp **0.08**

RESULTS

(XY) PASS - Dimension <100 mm ±0.1 mm. Dimension >100 mm ±0.15%

X				Y			
	Actual	Error	PASS		Actual	Error	PASS
7	7.03	0.03	PASS	7	7.02	0.02	PASS
50	49.97	-0.03	PASS	50	49.98	-0.02	PASS
100	100.02	0.02	PASS	100	99.96	-0.04	PASS
150	150.02	0.02	PASS	150	150.00	0.00	PASS
200	200.01	0.01	PASS	200	200.00	0.00	PASS
7	7.01	0.01	PASS	7	7.01	0.01	PASS
50	49.98	-0.02	PASS	50	50.00	0.00	PASS
100	100.02	0.02	PASS	100	99.96	-0.04	PASS
150	150.01	0.01	PASS	150	150.02	0.02	PASS
200	199.98	-0.02	PASS	200	200.01	0.01	PASS
7	7.00	0.00	PASS	7	6.99	-0.01	PASS
50	50.01	0.01	PASS	50	49.98	-0.02	PASS
100	100.01	0.01	PASS	100	99.99	-0.01	PASS
150	150.00	0.00	PASS	150	149.98	-0.02	PASS
200	199.99	-0.01	PASS	200	200.00	0.00	PASS
7	7.00	0.00	PASS	7	7.01	0.01	PASS
50	49.96	-0.04	PASS	50	49.97	-0.03	PASS
100	99.96	-0.04	PASS	100	99.99	-0.01	PASS
150	149.95	-0.05	PASS	150	149.98	-0.02	PASS
200	199.96	-0.04	PASS	200	199.94	-0.06	PASS
7	7.00	0.00	PASS	7	6.99	-0.01	PASS
50	50.00	0.00	PASS	50	49.99	-0.01	PASS
100	99.98	-0.02	PASS	100	99.97	-0.03	PASS
150	149.97	-0.03	PASS	150	149.96	-0.04	PASS
200	199.98	-0.02	PASS	200	199.96	-0.04	PASS

Detail

This multi-test part highlights the detail that can be achieved on the Stratasys Neo.

The Neo can achieve the highest resolution and tolerances, including fine feature details, thin walls and holes, that could be challenging for legacy 3D printers.

Thin walls from
1.6mm-0.3mm in
0.1mm increments

Superior sidewall quality

Thin slots from
1.6mm – 0.2mm in
0.1mm increments

Fine feature detail

Hole features from
2mm – 0.4mm in
0.2mm increments



Titanium Software

All Neo systems operate with industry-leading Titanium™ software.

Built-in Titanium Software has customizable build options and features that can help operators produce high-quality parts. For example, on-the-fly parameter adjustment and upper surface build quality optimization improve part quality.

The Stratasys Neo stereolithography 3D printer produces highly accurate parts with unparalleled industry quality. The Stratasys Neo is a reliable, stable system, proven in high-pressure working environments like service bureaus and F1, that require quick turnarounds.

Stratasys Neo delivers:

- Outstanding sidewall accuracy
- Exceptional layer-to-layer alignment
- Crisp feature resolution
- Superior accuracy
- Extremely small variability from part to part

The Neo is known for its reliability and exceptional ability to produce high-quality parts with superior surface finish and detail.

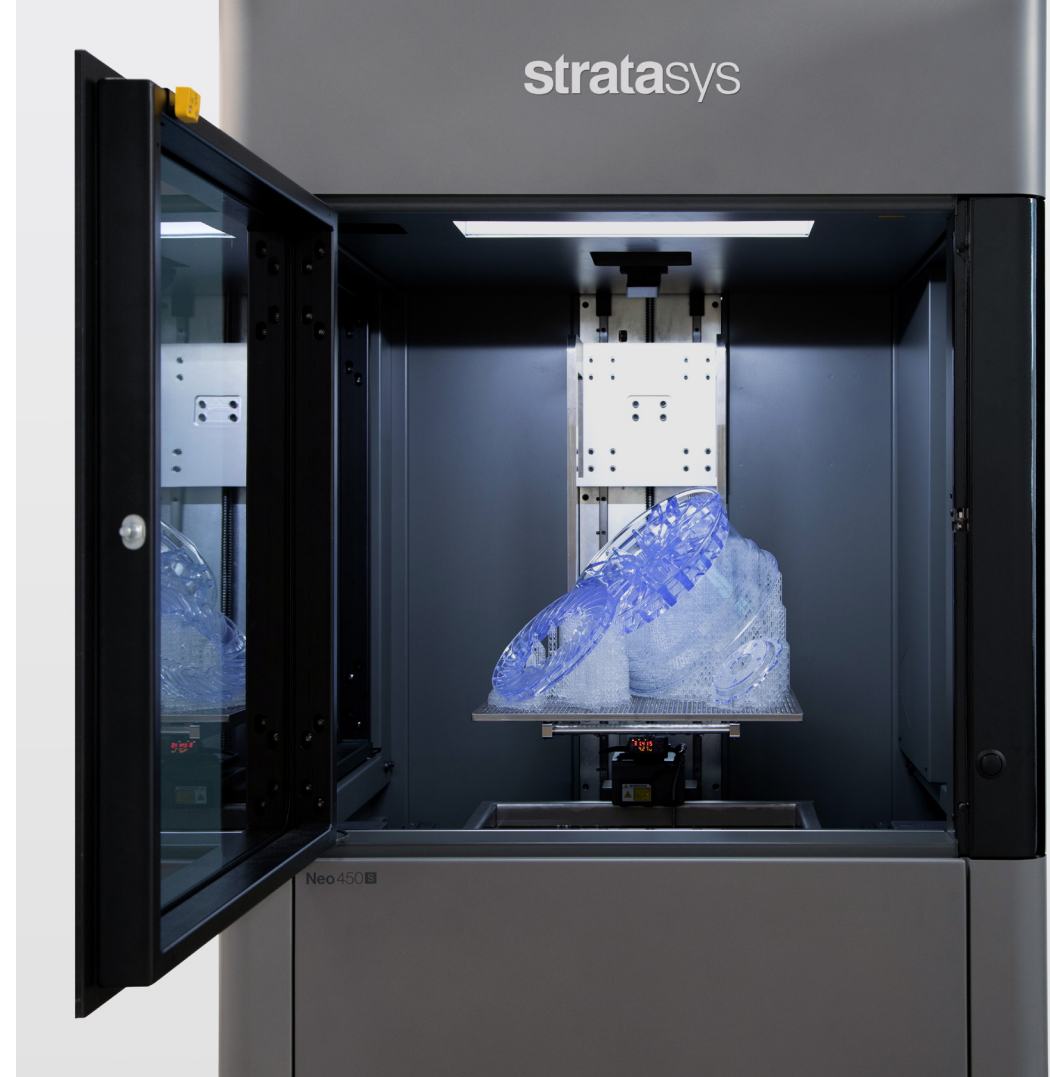

Stratasys Headquarters

7665 Commerce Way,
Eden Prairie, MN 55344
+1 800 801 6491 (US Toll Free)
+1 952 937-3000 (Intl)
+1 952 937-0070 (Fax)

stratasys.com

ISO 9001:2015 Certified

1 Holtzman St., Science Park,
PO Box 2496
Rehovot 76124, Israel
+972 74 745 4000
+972 74 745 5000 (Fax)

© 2021 Stratasys Ltd. All rights reserved. Stratasys, Stratasys signet, Neo and Titanium are trademarks or registered trademarks of Stratasys Ltd. and/or its subsidiaries or affiliates and may be registered in certain jurisdictions. All other trademarks belong to their respective owners. Product specifications subject to change without notice. eB_SL_Upgrade to Neo_1021a

